



*Aliaxis*



## **MECHANICAL ENGINEERING**

Components made of  
FRIALIT®-DEGUSSIT®  
High-Performance Ceramics

[www.friatec.com/ceramics](http://www.friatec.com/ceramics)



# FRIALIT®-DEGUSSIT® HIGH-PERFORMANCE CERAMICS **MEETING THE HIGHEST REQUIREMENTS**

In mechanical engineering, the requirements imposed on components made of high-performance ceramics are continually increasing. It is our challenge to meet these requirements with extensive experience and expert technical knowledge.

Machine components made of FRIALIT-DEGUSSIT High-Performance Ceramics are characterised by superior properties:

- High degree of hardness and resistance to wear
- Corrosion resistance to acids and alkalis
- High resistance to mechanical stresses
- Temperature resistance up to 1,950°C

The choice of the right material is most significant for the design of each technical component. A variety of aspects needs to be considered carefully before finally making this decisive choice. We would like to help you select the right material. Benefit from our years of experience that we have gained in the most varied of applications using our components.

## **ADVANTAGES**

- Competent application engineers at FRIATEC AG support material-appropriate design and material selection.
- Years of material development pay off with unequalled material properties; corrosion and temperature resistance take the top positions.
- A good network with universities and research institutes ensures suitable partnerships for research projects and innovations.
- The worldwide sales network offers local personal contact for customers abroad.
- The complete manufacturing process from body preparation to the finished component takes place at our site in Mannheim.
- Customised integrated ceramic solutions from a single source.



**Benefit from  
150 years' experience in ceramics.**

# FRIALIT®-DEGUSSIT® MECHANICAL ENGINEERING **PUMP COMPONENTS**

Our high-performance materials and extensive experience in construction and development of customised components give your machine components extended service lives and high operational reliability.



Spacer cans made of FRIALIT FZM



High-pressure piston made of FRIALIT FZM  
with shrink-fitted metal support ring

## **SPACER CANS**

Spacer cans made of FRIALIT-DEGUSSIT High-Performance Ceramics allow for maintenance-free and leakage-free shaft seals in magnetically coupled rotary pumps. The hermetically sealed housing prevents corrosive or highly toxic media from escaping and not the smallest amount of system-related leakage occurs which benefits employees and the environment. Here, ceramics show their strength: outstanding corrosion resistance and virtually perfect non-magnetisability prevent corrosion and eddy-current losses. Depending on their size, the high mechanical strength of ceramic spacer cans allows them to be used at 450 °C and pressures of 60 bar.

## **HIGH-PRESSURE PISTONS**

Pistons made of ceramic materials FRIALIT F99.7, FRIALIT FZT, FRIALIT FZM or FRIALIT FZM/K are used to convey liquid and high-viscosity media even when they contain abrasive components. The pistons manage pressures up to 10,000 bar and are used in applications such as water jet cutters, high-pressure cleaners, desalination plants and cooling, rinsing or filtration circuits. The good wear resistance and ideal sliding properties ( $R_a < 0.05 \mu\text{m}$ ) enable enhanced service lives of more than 4,000 h at 3,000 bar while only developing a little frictional heat.

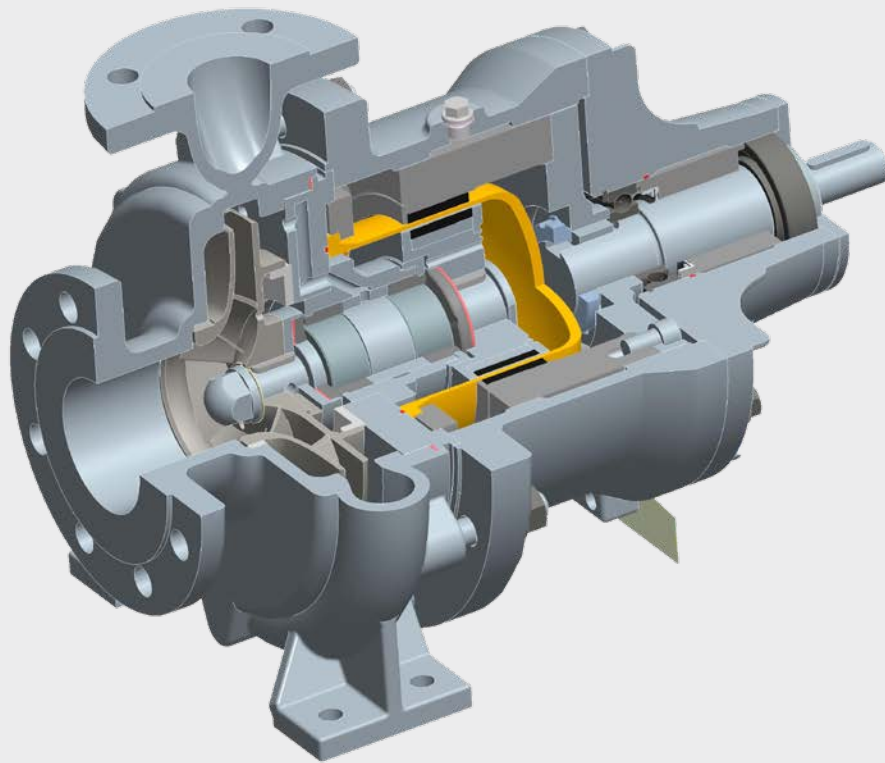

Source: Klaus Union



Pump impeller made of FRIALIT FZM, approx. diameter 300 mm

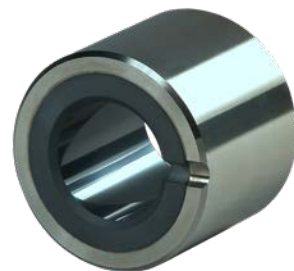

Product-lubricated slide bearing made of FRIALIT SiC198D

## PUMP IMPELLERS

Pump impellers for rotary pumps made of FRIALIT F99.7 or FRIALIT FZM are suitable for special pumps used under extreme conditions. Depending on the housing construction, highly corrosive, abrasive and hot media can be transported. Diffusion bonding allows for the manufacture of very complex pump impeller geometries that could not be achieved with conventional techniques.

## SLIDE BEARINGS

Ceramic slide bearings with FRIALIT SiC 198D or FRIALIT FZM sliding partners are used successfully in agitators and pumps for the food processing industry, pharmaceutical industry and chemicals industry. Outstanding surface qualities ensure excellent sliding properties as well as sterilisation and purification of components without disassembly (CIP/SIP). Media-lubricated slide bearings with magnetic couplings can solve any problem in sealing applications.

# FRIALIT®-DEGUSSIT® MECHANICAL ENGINEERING **DOSING COMPONENTS**

Precision-fit piston cylinder units ensure low leakage and low wear. With our material, there is no need to worry about corrosion.



Control disc made of FRIALIT F99.7



Platinum-cermet-electrode sintered into a component made of FRIALIT FZM for magnetic flow measurement

## **SLIDES AND SEALING DISCS**

Pairs of sealing discs for filling, processing and mixing plants enable precise dosing of most varied media. The so-called stick-slip effect can be avoided by specific adjustment of the surface roughness of sliding surfaces to guarantee smooth running.

## **FLOW METERS**

The magnetic-inductive flow measurement of liquids of most different viscosities requires an electrically insulating pipe segment with a pair of electrodes of precise size and position. This is exactly what flow meters made of FRIALIT FZM with a sintered platinum-cermet-electrode achieve. The unique FRIATEC sintering technology guarantees consistent tightness at the joint even if exposed to high pressure.



Source: KRONES AG



Fitted piston/cylinder units made of FRIALIT F99.7

## PISTON AND CYLINDER UNITS

The use of ceramics significantly increases the safety and productivity in liquid filling machines. The FDA approval of ceramic materials FRIALIT F99.7, FRIALIT FZT and FRIALIT FZM allows safe use in different sectors such as the food, pharmaceutical and the chemical industry. Unlike conventional constructions, the use of FRIALIT ceramics achieves a seal without sealing elements using high-precision fitting of pistons and cylinders (gap clearance  $\leq 3 \mu\text{m}$ ). Our ceramic components solve the problem of purification and sterilisation of components without disassembly (CIP/SIP).

# FRIALIT®-DEGUSSIT® MECHANICAL ENGINEERING **GRINDING AND CRUSHING**

Our wear-resistant and FDA-certified materials allow the crushing of extremely durable and contamination-sensitive materials.



Grinding body made of FRIALIT FZM and FRIALIT F99.7



Grinding vessel with cover made of FRIALIT FZM

## **GRINDING BODIES**

Grinding bodies made of FRIALIT-DEGUSSIT High-Performance Ceramics are non-magnetisable and are characterised by high wear resistance. High chemical resistance and inert property allow them to be used even with an extremely sensitive grinding stock. Minimal abrasion does not affect purity which is of decisive importance when preparing probes for analyses.

## **GRINDING VESSELS**

Grinding vessels are available in different sizes and designs. The material's excellent mechanical properties guarantee maximum service life at minimum wear – even at high temperatures and with highly corrosive media. FRIALIT FZM and FRIALIT F99.7 are certified in accordance with FDA guidelines.





Large separator wheel made of FRIALIT F99.7 (outer diameter 300 mm)

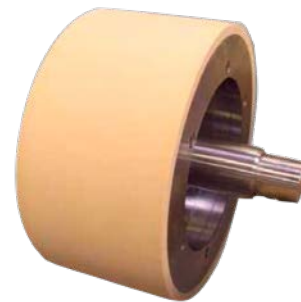

Ceramic roller body made of FRIALIT F99.7 (outer diameter 250 mm), metal-to-ceramic bond

## SEPARATOR WHEELS

Separator wheels made of FRIALIT-DEGUSSIT High-Performance Ceramics meet the most stringent requirements because of their superior material properties and sophisticated design. Ceramics show their strength when in contact with highly abrasive grinding stock: the result is low maintenance and cost reduction. The low specific weight has a positive effect on occurring forces and contributes to smooth operation.

## ROLLER BODIES

Roller bodies made of FRIALIT-DEGUSSIT High-Performance Ceramics are used in pairs to crush very hard materials. The product is not contaminated, and the ceramic roller body made of FRIALIT F99.7 and FRIALIT FZM easily withstands challenging applications. To obtain the desired result, we generally recommend a metal-to-ceramic compound that combines the benefits of both materials in one component.

# FRIALIT®-DEGUSSIT® MECHANICAL ENGINEERING **POSITIONING AND WELDING PINS**

The special composition of our unique materials guarantees maximum hardness and wear resistance allowing exact positioning even after many cycles.



**Maximum  
precision and  
service life**



Full ceramic welding pin made of FRIALIT HP79



Ceramic cap positioning pins made of FRIALIT FZT with metal substrate



Ceramic rod positioning pins made of DEGUSSIT DD57 with metal substrate

Well-known car manufacturers use positioning and welding pins made of FRIALIT-DEGUSSIT High-Performance Ceramics. The advantages are obvious: high wear resistance and hardness of FRIALIT materials ensure precise positioning in batch production. Compared with steel, ceramics show a 100-fold increase in service life thus achieving constant high precision. Material properties such as electrical insulation and high-temperature resistance allow for effortless use of the positioning pins requiring low maintenance over a long period.

A material combination of metal and ceramics allows for optimised and cost-efficient designs that use ceramics only when necessary. Our extensive experience with metal-to-ceramic assemblies allows us to offer the most varied and customised solutions. Benefit from low tooling costs, reduced downtimes and at the same time minimal service and maintenance costs.

We draw from a wide portfolio of FRIALIT-DEGUSSIT High-Performance Ceramics to meet different customer requirements. We would be pleased to help you choose the right material depending on the type of your application.

# FRIALIT®-DEGUSSIT® MECHANICAL ENGINEERING **FORMING TOOLS**

When combining metal and ceramics, higher hardness is achieved through sophisticated design that leads to enhanced service life and reduced failure probability.



Drawing ring made of FRIALIT FZM, shrink-fitted into metal housing



Different forming tools made of FRIALIT FZM and FRIALIT FZT, some with metal-to-ceramic bond

## **DRAWING RINGS**

FRIALIT-DEGUSSIT High-Performance Ceramics offer a combination of material properties that are ideal for use with application-oriented designs. The excellent wear resistance at very high mechanical stresses leads to outstanding efficiency in particular for drawing technology. Our materials allow long service lives and outstanding surface qualities with ideal drawing behaviour. These benefits are maintained even at high temperatures and in corrosive environments. The use of drawing grease or drawing oils can be reduced significantly or even eliminated.

## **EXTRUSION DIES**

Punches moving in opposite directions in sleeves/dies compress powder into compact components using high pressure. Wall friction on the inside of the die causes heavy wear on the die wall due to interacting corrosion and abrasion. FRIALIT-DEGUSSIT High-Performance Ceramics show significantly better resistance to friction wear and chemical attacks than metal. An external metal sleeve is shrink-fitted onto the ceramic absorbing critical stresses and toughening the ceramic using compressive stress i.e. leading to enhanced strength.



Forming roller (external diameter 200 mm) made of FRIALIT FZM



Forming cylinders made of FRIALIT FZM

## FORMING ROLLERS

Ceramic rollers made of FRIALIT-DEGUSSIT High-Performance Ceramics for metal forming have shown excellent results as an alternative to conventional materials. High hardness and wear resistance of ceramics combined with high temperature resistance guarantee 20-fold service lives when compared with steel tools. This allows reduced tool inventories and less tool repair and maintenance work. In specific cases, tools no longer require cooling. The high surface quality of ceramics and little adhesion tendency towards metal results in better surfaces and quality of the rolled components when using ceramic instead of metal materials. In addition, FRIALIT-DEGUSSIT High-Performance Ceramics are

chemically inert and do not react with metals or their oxides. Their resistance to almost any acids and alkalis makes them suitable for the most difficult ambient conditions.

# FRIALIT®-DEGUSSIT® HIGH-PERFORMANCE CERAMICS **SURFACE FINISHING**

The finest surfaces and long service life: our unique DEGUSSIT DD57 sintered ruby material obtains its red colour, extreme hardness and wear resistance through a special doping procedure.

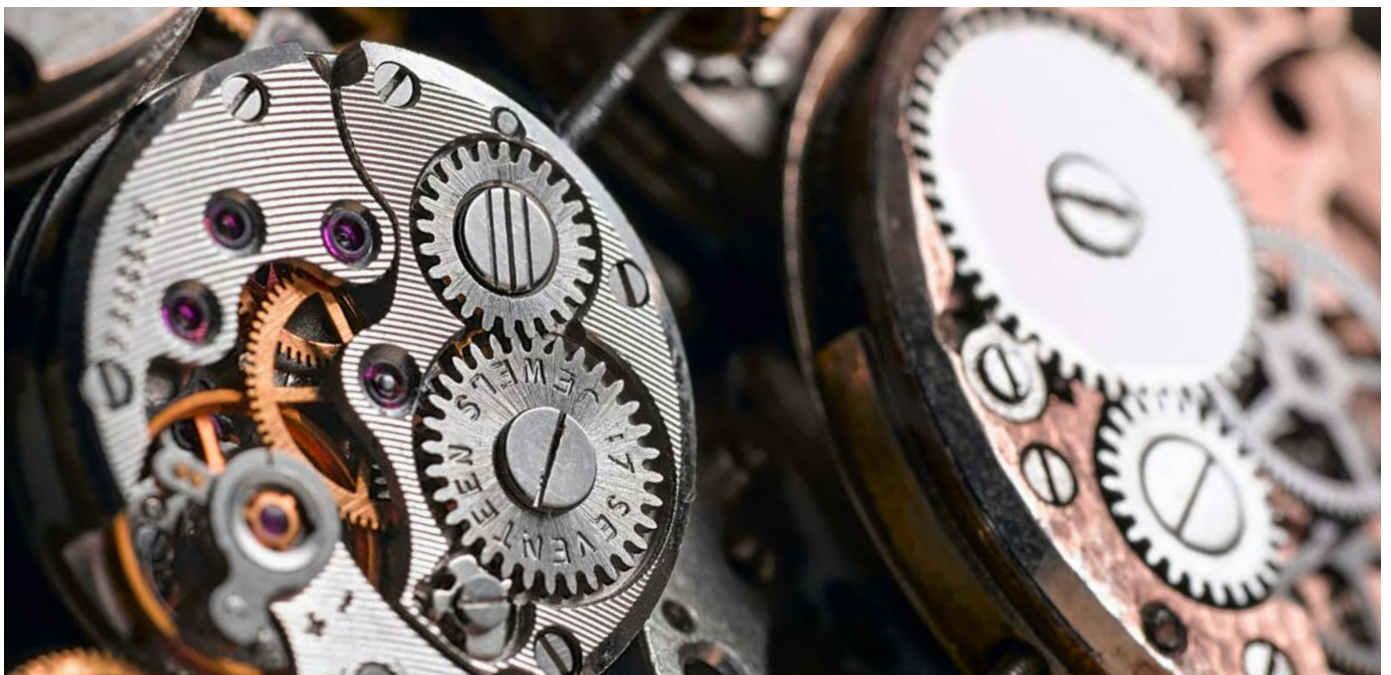

## Highest quality for unequalled surface finishes



Fine grinding tools made of DEGUSSIT DD57, square, triangular, half-round and round



Grinding disc made of DEGUSSIT DD57 with brass mounting



Mounted points made of DEGUSSIT DD57 with brass mounting for clamping

FRIATEC fine grinding tools are free of binders and suitable for processing of virtually all common hard materials such as glass, porcelain or hard metal. The specific doping with additives allows DEGUSSIT DD57 sintered ruby to achieve extremely high hardness similar to that of diamond, very high wear resistance and its deep-red colour. Our fine grinding tools are used for the manufacture of accurate fine precision devices in the watch, glass and jewellery industry or as knife sharpeners among others. When using DEGUSSIT DD57 fine grinding tools

in grinding processes, unequalled surface qualities can be achieved when grinding, lapping, honing and roller burnishing. When using DEGUSSIT fine grinding tools for machining, the surface of work pieces is not only machined but can also be hardened and polished with pressure when using the finest grade. Our range of products comprises files, hand lappers, grinding wheels, grinding tools, bench stones and mounted points from coarse to medium and fine. Customised components can be manufactured on request.

# FRIALIT®-DEGUSSIT® CUSTOMISED PRODUCTS FOR SPECIAL APPLICATIONS

Our varied manufacturing and machining abilities allow for high-precision production of large and complex components.

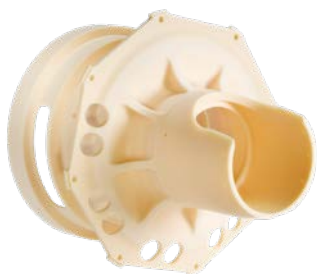

Camera housing made of FRIALIT F99.7 for the aerospace industry



Dielectric rails for fuel cells made of FRIALIT F99.7

## CAMERA HOUSINGS

In-house 5-axis CNC machining supported by ultrasonic processing allows the manufacture of complex components such as this camera housing. The permeability of ceramics for electromagnetic radiation takes effect in this type of application: the electromagnetic waves of the sensors inside the housing can penetrate to the outside, while radar beams from outside are hardly reflected thus impeding detection of the aircraft.

## DIELECTRIC RAILS FOR FUEL CELLS

Breaking ground requires new methods: corrosion resistant dielectrics are needed for high temperatures in fuel cell technology. This is where FRIALIT-DEGUSSIT High-Performance Ceramics come in. Precision rails are machined precisely to a few  $\mu\text{m}$  along the entire length to ensure high-precision distances and electrical insulation in MFCs (= Molten Carbonate Fuel Cells).





Fuel cell power plant on the FRIATEC site.

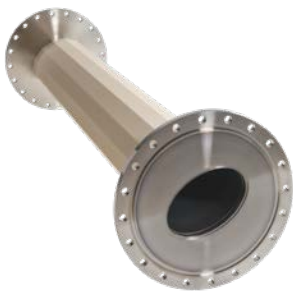

Vacuum chamber made of FRIALIT F99.7, metal-to-ceramic bond (length 1350 mm, diameter 320 mm)



Housing for X-ray image intensifier made of FRIALIT F99.7

## VACUUM CHAMBERS

Ceramic vacuum chambers made of FRIALIT-DEGUSSIT High-Performance Ceramics are required and used in renowned particle accelerators such as the LHC at CERN, the DESY in Hamburg or the HIT in Heidelberg. These components have excellent properties, which make them ideal for high-voltage insulation or beam deflection using fast-pulsed magnets. The combination of FRIALIT F99.7 and metal shows minimum leakage and outgassing rates making it perfect for use in the ultra-high vacuum (UHV). A thin titanium coating on the inner sides of the ceramic chambers allows image charges to be discharged reliably.

## HOUSINGS FOR X-RAY IMAGE INTENSIFIERS

Key components in medical technology such as housings for X-ray image intensifiers require a combination of metal and ceramics. FRIALIT-DEGUSSIT components not only meet the highest standards of precision and reliability, they also combine the advantages of both materials in one component: weldable or screwable metal on one side and electrically insulating ceramics with high dielectric strength on the other side, both strongly bonded to each other. Our customers benefit from the highest process reliability, thanks to state-of-the-art facilities and years of experience in ceramic brazing.

# FRIALIT®-DEGUSSIT® HIGH-PERFORMANCE CERAMICS MANUFACTURING PROCESS

The ceramic manufacturing process from the raw material to the finished product is fundamentally different from metal or plastic production: time, effort and costs make ceramics ideally suited for special applications.

Due to technical reasons, ceramic parts shrink during the sintering process at approx. 1,800°C. For economic reasons, close tolerances should be avoided unless essential. Generally, compliance with dimensional tolerances of  $\pm 1\%$  is possible without subsequent treatment. Diamond tools can be used for grinding the respective surfaces to achieve tolerances that are more precise.

Although no technical difficulties arise during grinding, the process requires increased effort and makes the product more expensive. Please contact us during the design phase to discuss and find the appropriate solution that meets all technical requirements and at the same is economic and suitable for ceramics – it is worth it!



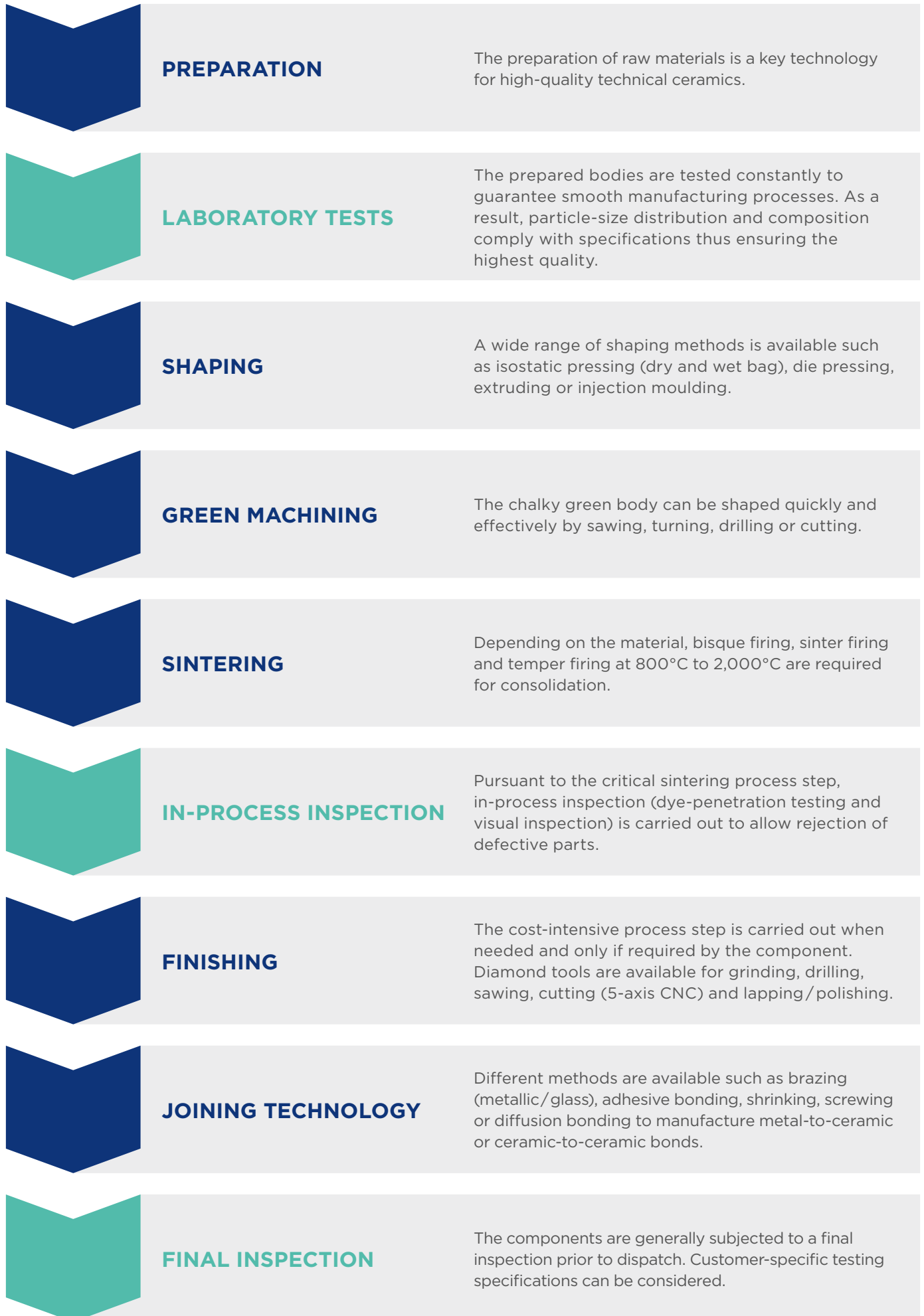

# FRIALIT®-DEGUSSIT® HIGH-PERFORMANCE CERAMICS JOINING TECHNOLOGIES

Demanding applications often require different material properties to be combined in one component. The suitable joining technology is therefore a challenge for material scientists.

Ceramic-to-metal assemblies combine the properties of each individual material. As a result, the assembly shows significantly better properties. This is achieved through use of the material under conditions that fit its suitability profile.

FRIATEC has developed a variety of innovative solutions in cooperation with customers. Areas of applications range from machine, pump and plant engineering to high-temperature and electrical applications.

## ADHESIVE BONDING

Epoxy resin-based adhesives have shown excellent results for many ceramic-to-metal applications. They are characterised by:

- Good mechanical properties
- Good general chemical resistance

- Low curing shrinkage
- Easy processing without pressure using the polyaddition reaction

The main advantage of adhesive bonds is their uncomplicated combining of different materials. Ceramic-to-metal adhesive bonds can reach tensile strengths of 50 MPa at room temperature when suitable adhesives and a suitable design for the use of adhesives are selected. However, these joints consist of organic adhesives and are subject to an ageing process. In addition, they should not be exposed to temperatures exceeding 150°C for extended periods of time. Special high-performance adhesives can be used at application temperatures of up to 250°C. If higher temperatures are required, only inorganic adhesives can be used. These adhesives usually consist of mineral fillers such as Al<sub>2</sub>O<sub>3</sub>, ZrO<sub>2</sub> and MgO and a binder phase consisting of water glass, water-soluble aluminosilicates or phosphates.

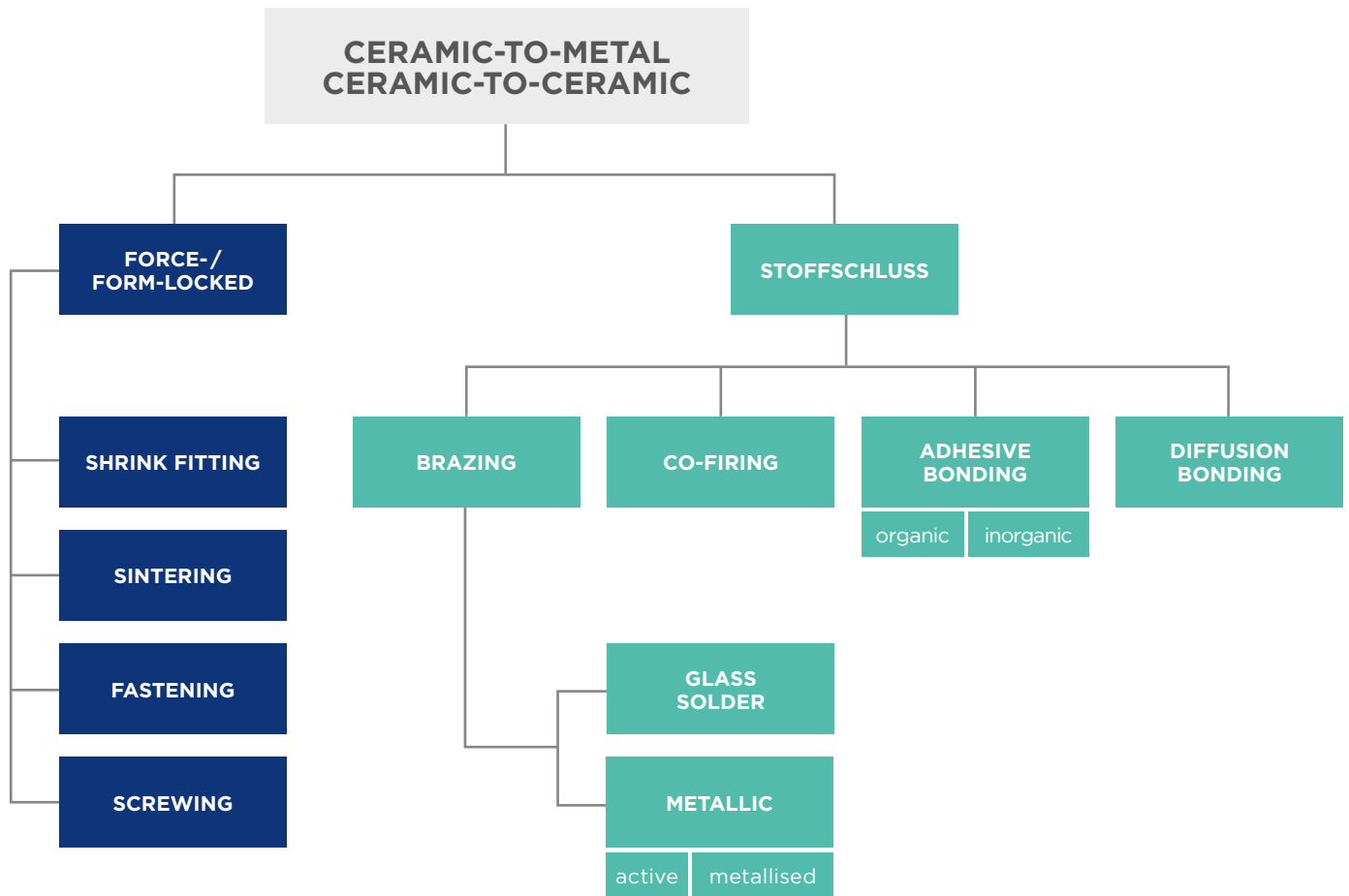

Overview of joining techniques

However, the strength values are far below those of organic adhesives, depending on the curing mechanism, at 10 to 20% of standard epoxy resin adhesives. The decisive advantage of these adhesives is that they can be used at very high application temperatures, up to a maximum of 1,750°C. Graphite systems can be used at temperatures of up to 2,900°C under protective gas.

## BRAZING

The brazing of ceramics and metal parts is a technologically sophisticated joining technique and is used primarily for current-carrying components in vacuum technology. Due to different coefficients of thermal expansion, there are limits with regard to material selection when combining ceramics and metal. The use of classic metal brazes is limited due to the low wetting capacity of ceramic surfaces. To enable sufficient wetting behaviour of the braze, prior metallisation of

the ceramic surface or modification of the metal braze are required thus allowing direct wetting of the ceramic.

With regard to the brazing process, brazing of metallised ceramics is to be distinguished from active brazing. With a metallisation width of at least 2 mm, the strength of these joints exceeds 50 MPa. He-leakage rates of  $<10^{-10}$  mbar\*l/s can be achieved even for large components. Brazing of metallised ceramics is a technology that has proved efficient for joining ceramic and metal components over many decades. The Mo-Mn method has shown excellent results. The metallisation has a layer thickness of approx. 15–35 µm.

# FRIALIT®-DEGUSSIT® HIGH-PERFORMANCE CERAMICS JOINING TECHNOLOGIES



Glass-soldered ozone generator



Diffusion-welded pump impeller

## GLASS SOLDERING

Glass soldering is appropriate for gas-tight joining of ceramic components. This joining technique is characterised by a very good general chemical resistance and operating temperatures up to approx. 1,100°C. These joints can easily achieve strengths of 100 MPa at room temperature. There is great freedom of design with regard to realisable geometries because glass soldering is less complex than brazing metallic materials. It can be carried out under an oxidising atmosphere and does not require metallisation. The bond is 100% gas-tight and chemically inert.

## DIFFUSION BONDING

Diffusion bonding is also known as pressure welding and joins components at higher temperatures but below the melting point. This technique can be used to join ceramic components. The contact surfaces of the components to be joined require precise machining with regard to surface quality and shape tolerances. As a result, diffusion produces material-bonded assemblies of the individual components. Ceramic pump impellers with curved blades are just one example for complex ceramic components that are manufactured using this joining technique.

## Ceramic-to-metal bonds for an ideal combination of properties



Component with sintered platinum-cermet-electrode for magnetic-inductive flow measurement

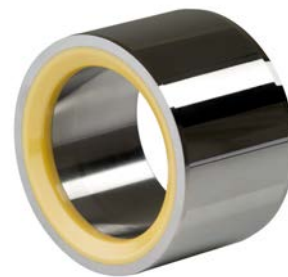

Drawing ring, shrink-fitted into metal housing

### CO-FIRING

Sintering both materials in one firing process is another option for joining ceramics and metal. The ceramic part is shrink fitted onto a high-temperature resistant metal or cermet body. One of the few materials that can be used is platinum with a melting point of approx. 1,770°C and an excellent resistance to oxidation. Measurement cells for magnetic-inductive flow meters (EMF) are the classic example for the highly successful use of this technology. Conductors such as platinum wires or platinum-based cermets used in state-of-the-art EMFs are required for voltage tapping and are joined with FRIALIT FZM type ceramics using sintering. Variants with cermet electrodes show He-leakage rates of  $<10^{-10}$  mbar\*l/s and can be exposed to bursting pressures of  $>1,000$  bar.

### SHRINK FITTING

A press joint is one example of a force-locked joint that is appropriate for ceramics. Shrink fitting allows a metal part on the outside to be fitted onto a ceramic part on the inside. The outer part is heated to push the metallic body on the outside over the oversized ceramic core. The metal part is shrink-fitted onto the ceramic part through thermal elastic recovery as it cools. Since ceramic materials have extreme compressive strength, this design principle accommodates the strength properties of the ceramic.

In-house tests with test pieces have proved the high strength of press joints. Vacuum-tight joints can be achieved by inserting an additional intermediate layer of ductile metal between the part on the inside and the outside.

# TECHNOLOGY

## MATERIAL PROPERTIES

Properties		Unit	Material FRIALIT FZM/K
Main components		-	ZrO <sub>2</sub> , Y <sub>2</sub> O <sub>3</sub> , Al <sub>2</sub> O <sub>3</sub>
Purity		wt-%	≥ 99.8
Density		g/cm <sup>3</sup>	≥ 6.0
Open Porosity		Vol.-%	0
Residual porosity		Vol.-%	-
thereof Open porosity		Vol.-%	-
Average size of crystallites		µm	0.8
Bending strength $\sigma_m$	DIN EN 843-1	MPa	1,000
Weibulls modulus		-	10
Toughness $K_{Ic}$	SEVNB	MPa * m <sup>0.5</sup>	4.6
Compressive strength		MPa	2,200
Young's modulus	static	GPa	200
Poisson's ratio		-	0.3
Hardness	HV1	-	1,420
Maximum service temperature	in air inert atmosphere	°C	1,000 -
Linear coefficient of expansion	-100 - 20 °C	10 <sup>-6</sup> /K	-
	20 - 100 °C		-
	20 - 500 °C		-
	20 - 900 °C		-
	20 - 1,000 °C		10.5
Specific heat	20 °C	J/(kg * K)	400
Thermal conductivity	20 °C	W/(m * K)	-
	100 °C		2.5
	500 °C		-
	900 °C		-
	1,000 °C		-
	1,500 °C		-
Resistivity	20 °C	Ω * cm	-
	50 °C		5 * 10 <sup>10</sup>
	100 °C		2.5 * 10 <sup>9</sup>
	300 °C		4.5 * 10 <sup>5</sup>
	600 °C		8 * 10 <sup>3</sup>
	900 °C		-
	1,000 °C	15	
Dielectric strength	20 °C	kV/mm	> 5
Typical colour		-	white

The data indicated on this table are in line with the introductory German Industrial Standard DIN 60672-2 and relate to test specimens from which they were obtained. They are not unconditionally applicable to other forms of the same material. The data must be regarded as indicative only. All data refer to a temperature of 20°C, unless otherwise specified.



Material FRIALIT F99,7	Material FRIALIT FZM	Material FRIALIT FZT	Material FRIALIT SiC 198D	Material FRIALIT HP 79	Material DEGUSSIT DD57
$\alpha - \text{Al}_2\text{O}_3$	$\text{ZrO}_2, \text{MgO}$	$\text{Al}_2\text{O}_3, \text{ZrO}_2$	SSiC	$\text{Si}_3\text{N}_4, \text{Al}_2\text{O}_3, \text{RE}_2\text{O}_3$	$\text{Al}_2\text{O}_3, \text{Cr}_2\text{O}_3$
> 99.5	> 99.7	> 99.5	-	-	> 99.5
$\geq 3.90$	$\geq 5.70$	$\geq 4.10$	> 3.08	3.18–3.41	$\geq 3.90$
0	0	0	-	-	0
-	-	-	> 3	0.5	-
-	-	-	0	0	-
10	50	5	-	-	10
350	500	460	460	900	300
> 10	> 15	> 15	$\geq 12$	15	-
3.5	6.3	3.3	-	-	-
3,500	2,000	3,000	> 2,500	3,000	3,000
380	185	360	420	310	380
0.22	0.3	0.24	0.15	0.26	0.22
1,760	1,220	1,880	2,650	1,630	1,660
1,950	900	1,700	1,650	1,200	1,950
-	-	-	1,900	1,400	-
5.5	7.7	4.9	-	-	-
-	-	-	-	-	7.5
7.3	10.4	7.5	-	-	-
-	10.6	-	-	-	-
8.2	-	8.3	4.5	3.2	8.5
900	400	850	672	700	900
34.9	3	-	100	24	34.9
-	-	25	-	-	-
-	2.3	-	-	-	-
-	2	-	-	-	-
6.8	-	-	-	-	-
5.3	-	-	-	-	-
$10^{15}$	$10^{10}$	-	$1 * 10^7$	$1 * 10^{11}$	-
-	-	-	-	-	-
-	-	-	-	-	-
-	-	-	-	-	-
-	84	-	-	-	-
$10^7$	-	-	-	-	-
> 30	-	-	-	-	-
ivory	yellow	white	black	black	red

# FRIALIT®-DEGUSSIT® HIGH-PERFORMANCE CERAMICS CERAMIC INNOVATIONS SINCE 1863

## ELECTRICAL ENGINEERING

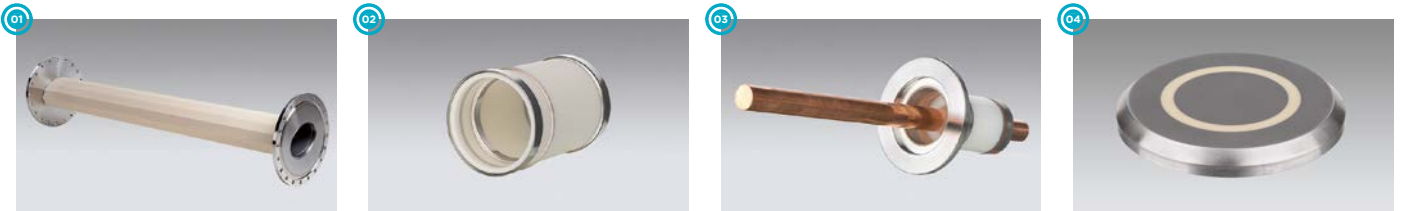

## HIGH-TEMPERATURE TECHNOLOGY



## MECHANICAL ENGINEERING

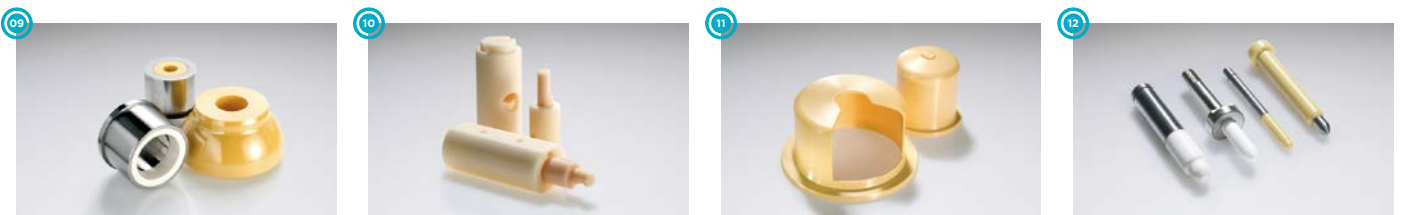

## SURFACE FINISHING

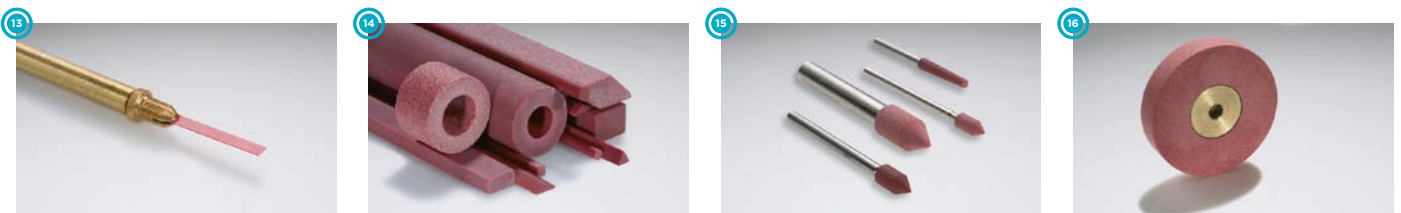

- 01. UHV vacuum chamber
- 02. Special insulation tube for physicsresearch institutes
- 03. Feedthroughs with ISO-KF flange
- 04. Humidity sensor

- 05. Rectangular tubes
- 06. Multi-bore tubes
- 07. Crucibles, boats and annealing boxes
- 08. Plates with hole

- 09. Forming tools used in car body construction
- 10. Dosing unit used in the pharmaceutical and cosmetic industry
- 11. Spacer cans for the pump industry
- 12. Welding pins used in car body construction

- 13. Midget file
- 14. Grinding tools used in metal processing
- 15. Mounted points used in metal processing
- 16. Grinding wheel for the glass-processing industry

# FRIATEC

## INNOVATIVE SOLUTIONS FOR THE GLOBAL MARKET

### INNOVATIONS FOR MORE THAN 150 YEARS

The company was founded in 1863 in Mannheim, Germany, as a brickyard and succeeded in developing its first pathbreaking innovation, chemical stoneware, in 1888. Numerous new developments followed. Among other things, the company started in the mid of the past century processing plastics and combined modern and traditional materials when producing chemical devices and facilities. The following years were characterised by the expansion in the core business and the opening up of more and more new business segments. As Deutsche Steinzeug and later as Friedrichsfeld GmbH, the company, which has been operating under the name FRIATEC AG since 1993, continuously developed to become an internationally active, diversified company.

### SPECTRUM OF INNOVATIVE SOLUTIONS

As such, FRIATEC AG today offers a spectrum of innovative solutions for many industries, e.g. jointing technology for pipe systems but also ceramic components which are used in laboratory and electrical engineering but also in medical engineering. With its sophisticated solutions, FRIATEC AG is not only among the most well-known and well-established companies in the metropolitan region Rhine-Neckar but is also one of the global market leaders of its industry.

### PARTNER OF A POWERFUL COMMUNITY

Since 2003, FRIATEC AG has been a member of the ALIAXIS group of companies with headquarters in Brussels. ALIAXIS is the worldwide largest producer of plastic pipe systems for the construction industry, the industry and utilities.

**FRIATEC AG is a specialist  
company for products made  
of non-corroding and  
wear-resistant materials.**

*Aliaxis*

FRIATEC Aktiengesellschaft - Ceramics Division  
Steinzeugstraße 50 - 68229 Mannheim - Germany  
Phone +49 (0)621 486-1378 - info-frialit@friatec.de

[www.friatec.com/ceramics](http://www.friatec.com/ceramics)

